



## Selection Guide

Part No.	Dice	Lens Type	Iv (mcd) @ 20 mA		Viewing Angle
			Min.	Typ.	2θ1/2
AM2520SRD08	SUPER BRIGHT RED (GaAlAs)	RED DIFFUSED	50	150	40°
AM2520SRC08	SUPER BRIGHT RED (GaAlAs)	WATER CLEAR	120	600	20°

Note:

1. θ1/2 is the angle from optical centerline where the luminous intensity is 1/2 the optical centerline value.

## Electrical / Optical Characteristics at T<sub>A</sub>=25°C

Symbol	Parameter	Device	Typ.	Max.	Units	Test Conditions
λ <sub>peak</sub>	Peak Wavelength	Super Bright Red	660		nm	IF=20mA
λ <sub>D</sub>	Dominate Wavelength	Super Bright Red	640		nm	IF=20mA
Δλ <sub>1/2</sub>	Spectral Line Halfwidth	Super Bright Red	20		nm	IF=20mA
C	Capacitance	Super Bright Red	45		pF	V <sub>F</sub> =0V;f=1MHz
V <sub>F</sub>	Forward Voltage	Super Bright Red	1.85	2.5	V	IF=20mA
I <sub>R</sub>	Reverse Current	Super Bright Red		10	μA	V <sub>R</sub> = 5V

## Absolute Maximum Ratings at T<sub>A</sub>=25°C

Parameter	Super Bright Red	Units
Power dissipation	100	mW
DC Forward Current	30	mA
Peak Forward Current [1]	155	mA
Reverse Voltage	5	V
Operating/Storage Temperature	-40°C To +85°C	

Note:

1. 1/10 Duty Cycle, 0.1ms Pulse Width.

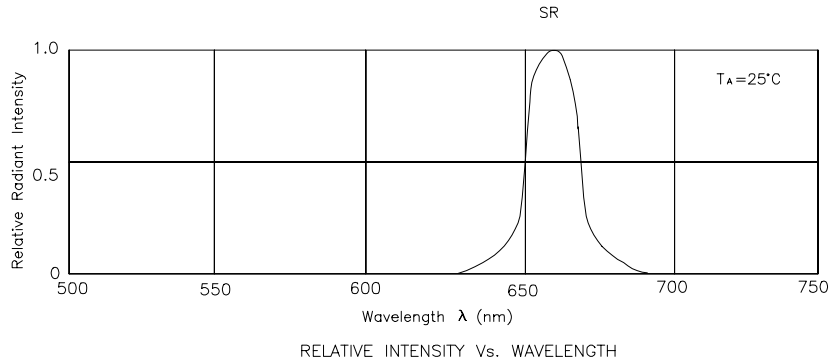

## Super Bright Red AM2520SRD08, AM2520SRC08

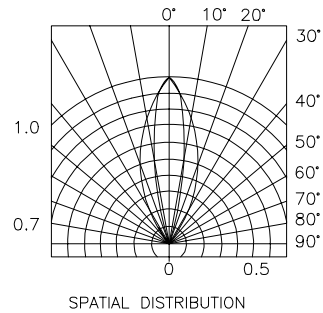
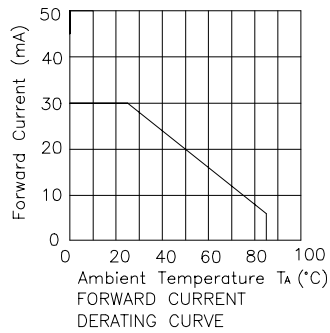
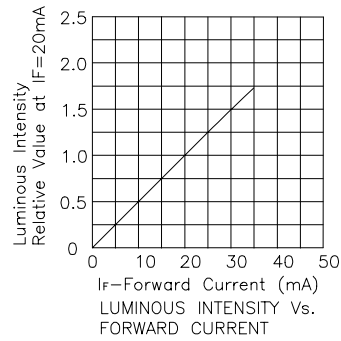
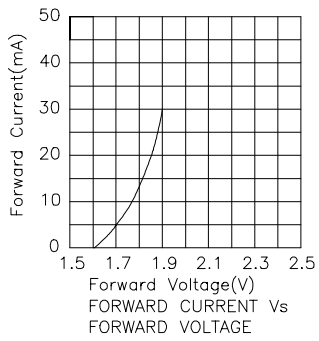

## AM2520SRD08 AM2520SRC08 SMT Reflow Soldering Instructions

Number of reflow process shall be less than 2 times and cooling process to normal temperature is required between first and second soldering process.

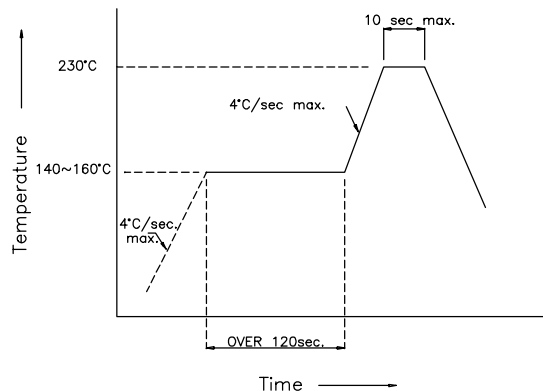

### Recommended Soldering Pattern (Units : mm)

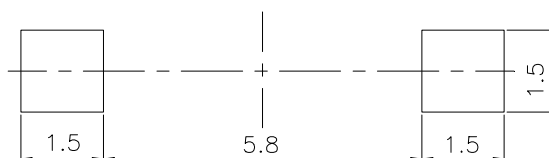

### Tape Specifications (Units : mm)

